

**KENWOOD**

CD PLAYER

**DP-492**

**INSTRUCTION MANUAL**

KENWOOD CORPORATION



B60-0794-00 (JA) (K, P, M, X, Y) (MG)  
92/12 11 10 9 8 7 6 5 4 3 2 1

# Introduction

Your choice of this product indicates that you are a devotee to excellence in sound reproduction.

We appreciate your patronage and take pride in the long tradition of quality components that our company represents.

So that you can get the most out of your unit, we suggest that you take the time to read through this manual before you hook up and operate your system. This will acquaint you with operating features and system-connection considerations so that your listening pleasure will be enhanced right from the start. You will notice that in all aspects of planning, engineering, styling, operating convenience and adaptability we have sought to anticipate your needs and desires.

**Keep this manual handy for future reference.**

## For your records

Record the serial number, found on the back of the unit, in the spaces designated on the warranty card, and in the space provided below. Refer to the model and serial numbers whenever you call upon your dealer for information or service on this product.

Model \_\_\_\_\_ Serial Number \_\_\_\_\_

## Unpacking

Unpack the unit carefully and make sure that all accessories are put aside so they will not be lost.

Examine the unit for any possibility of shipping damage. If your unit is damaged or fails to operate, notify your dealer immediately. If your unit was shipped to you directly, notify the shipping company without delay. Only the consignee (the person or company receiving the unit) can file a claim against the carrier for shipping damage.

We recommend that you retain the original carton and packing materials for use should you transport or ship the unit in the future.

## The marking of products using lasers (Except for some areas.)

**CLASS 1  
LASER PRODUCT**

The label is attached to the rear panel and says that the component uses laser beams that have been classified as Class 1. It means that the unit is utilizing laser beams that are of a weaker class. There is no danger of hazardous radiation outside the unit.

## For the USA

### CAUTION:

Use of controls or adjustments or performance of procedures other than those specified herein may result in hazardous radiation exposure.

In compliance with Federal Regulations, following are reproductions of labels on, or inside the product relating to laser product safety.

KENWOOD CORPORATION  
SHIONOGI SHIBUYA BUILDING 17-5,  
2-CHOME, SHIBUYA, SHIBUYA-KU,  
TOKYO, JAPAN

KENWOOD CORP. CERTIFIES THIS EQUIPMENT  
CONFORMS TO DHHS REGULATIONS NO. 21 CFR  
1040. 10, CHAPTER I, SUBCHAPTER J.

Location: Back Panel

## Accessories

- Audio cord ..... 1
- System control cord .... 1



- AC plug adaptor ..... 1  
(Except for some areas)

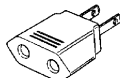

For the unit with a European AC plug in areas other than Europe.

## Contents

Caution: Read the pages marked  carefully to ensure safe operation.

Introduction.....	2	Programmed play (PGM mode).....	10
▲ Before applying power .....	3	Repeated play.....	12
▲ Safety precautions.....	3	Random play.....	13
▲ IMPORTANT SAFEGUARDS .....	4	Maintenance.....	14
System connections.....	6	In case of difficulty.....	15
Controls and indicators.....	7	Specifications .....	16
Manual play (TRACK mode).....	8		

**⚠ Caution: Read this page carefully to ensure safe operation.**

## Before applying power

### For the U.S.A. and Canada

#### Important!

Units shipped to the U.S.A. and Canada are designed for operation on 120 volts AC only.

**CAUTION:** TO PREVENT ELECTRIC SHOCK DO NOT USE THE AC PLUG WITH AN EXTENSION CORD, RECEPTACLE OR OTHER OUTLET UNLESS THE BLADES CAN BE FULLY INSERTED TO PREVENT BLADE EXPOSURE.

### For the United Kingdom

#### Important!

Units shipped to the U.K. are designed for operation on 240 volts AC only.

The mains plug must be removed from the wall socket prior to any internal examination.

The wires in this mains lead are coloured in accordance with the following code:

Blue ..... Neutral  
Brown ..... Live

The wires in this mains lead must be connected to the terminals in the plug as follows:

**Wire colour** ..... **Plug terminal marking**  
Blue ..... N or Black  
Brown ..... L or Red

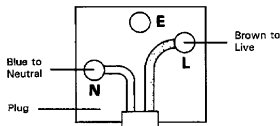

#### Notes:

1. If a 13-amp plug is used, this must be fitted with a 5-amp fuse.
2. If a 3-pin plug with earthing contact is used, no wire must be connected to the E terminal.

### For Australia and Europe

#### Important!

Units shipped to Australia are designed for operation on 240 V AC only.

Units shipped to Europe are designed for operation on 230 V AC only.

### For other countries

#### Important!

Units shipped to countries other than the above countries are equipped with an AC voltage selector switch on the rear panel. Refer to the following paragraph for the proper setting of this switch.

#### AC voltage selection

This unit operates on 110-120 or 220-240 volts AC. The AC voltage selector switch Type A or Type B on the rear panel is set to the voltage that prevails in the area to which the unit is shipped. Before connecting the power cord to your AC outlet, make sure that the setting position of this switch matches your line voltage. If not, it must be set to your voltage in accordance with the following direction.

#### Note:

Our warranty does not cover damage caused by excessive line voltage due to improper setting of the AC voltage selector switch.

#### AC voltage selector switch

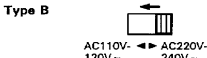
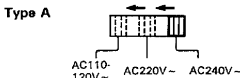

Move switch lever to match your line voltage with a small screwdriver or other pointed tool.

## Safety precautions

**WARNING:** TO PREVENT FIRE OR ELECTRIC SHOCK, DO NOT EXPOSE THIS APPLIANCE TO RAIN OR MOISTURE.



**CAUTION**  
RISK OF ELECTRIC SHOCK  
DO NOT OPEN



CAUTION: TO REDUCE THE RISK OF ELECTRIC SHOCK, DO NOT REMOVE COVER (OR BACK). NO USER-SERVICEABLE PARTS INSIDE, REFER SERVICING TO QUALIFIED SERVICE PERSONNEL.



THE LIGHTNING FLASH WITH ARROWHEAD SYMBOL, WITHIN AN EQUILATERAL TRIANGLE, IS INTENDED TO ALERT THE USER TO THE PRESENCE OF UNINSULATED "DANGEROUS VOLTAGE" WITHIN THE PRODUCT'S ENCLOSURE THAT MAY BE OF SUFFICIENT MAGNITUDE TO CONSTITUTE A RISK OF ELECTRIC SHOCK TO PERSONS.



THE EXCLAMATION POINT WITHIN AN EQUILATERAL TRIANGLE IS INTENDED TO ALERT THE USER TO THE PRESENCE OF IMPORTANT OPERATING AND MAINTENANCE (SERVICING) INSTRUCTIONS IN THE LITERATURE ACCOMPANYING THE APPLIANCE.

# IMPORTANT SAFEGUARDS

**⚠ Caution : Read this page carefully to ensure safe operation.**

Please read all of the safety and operating instructions before operating this unit. For best results, follow all warnings placed on the unit and adhere to the operating and use instructions. These safety and operating instructions should be retained for future reference.

**1. Power sources** — The unit should be connected to a power supply only of the type described in the operating instructions or as marked on the appliance.

**2. Power-cord protection** — Power-supply cords should be routed so that they are not likely to be walked on or pinched by items placed upon or against them, pay particular attention to cords at plugs, convenience receptacles, and the point where they exit from the unit.

Never pull or stretch the cord.



**3. Grounding or polarization** — The precautions should be taken so that the grounding or polarization means of this unit is not defeated.

**4. Ventilation** — The unit should be situated so that its location or position does not interfere with its proper ventilation.

To maintain good ventilation, do not put records or a table-cloth on the unit. Place the unit at least 10 cm away from the walls.

Do not use the unit on a bed, sofa, rug or similar surface that may block the ventilation openings.



**5. Water and moisture** — The unit should not be used near water — for example, near a bathtub, washbowl, kitchen sink, laundry tub, in a wet basement, or near a swimming pool, etc.



**6. Temperature** — The unit may not function properly if used at extremely low, or freezing temperatures. The ideal ambient temperature is above +5°C (41°F).

**7. Heat** — The unit should be situated away from heat sources such as radiators, heat registers, stoves, or other units (including amplifiers) that produce heat.

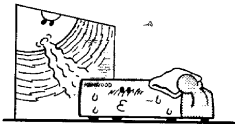

**8. Electric shock** — Care should be taken so that objects do not fall and liquid is not spilled into the enclosure through openings. If a metal object, such as a hair pin or a needle, comes into contact with the inside of this unit, a dangerous electric shock may result. For families with children, never permit children to put anything, especially metal, inside this unit.

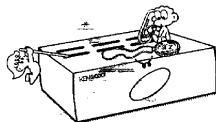

**9. Enclosure removal** — Never remove the enclosure. If the internal parts are touched accidentally, a serious electric shock might occur.

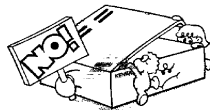

**10. Magnetic fields** — Keep the unit away from sources of magnetic fields such as TV sets, speaker systems, radios, motorized toys or magnetized objects.

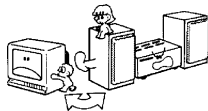

**11. Cleaning** — Do not use volatile solvents such as alcohol, paint thinner, gasoline, or benzene, etc. to clean the cabinet. Use a clean dry cloth.

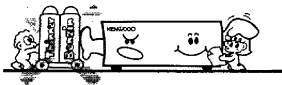

- 12. Carts and stands** — An appliance and cart combination should be moved with care. Quick stops, excessive force, and uneven surfaces may cause the appliance and cart combination to overturn.



- 13. Nonuse periods** — The power cord of the unit should be unplugged from the outlet when left unused for a long period of time.
- 14. Abnormal smell** — If an abnormal smell or smoke is detected, immediately turn the power OFF and pull out the power cord. Contact your dealer or nearest service center.

### POWER OFF!



- 15. Damage requiring service** — The unit should be serviced by qualified service personnel when:
- A.** The power-supply cord or the plug has been damaged; or
  - B.** Objects have fallen, or liquid has been spilled into the unit; or
  - C.** The unit has been exposed to rain; or
  - D.** The unit does not appear to operate normally or exhibits a marked change in performance; or
  - E.** The unit has been dropped, or the enclosure damaged.
- 16. Servicing** — The user should not attempt to service the unit beyond that described in the operating instructions. All other servicing should be referred to qualified service personnel.
- 17. Outdoor antenna grounding** — If an outside antenna is connected to the receiver, be sure the antenna system is grounded so as to provide some protection against voltage surges and built up static charges. Section 810 of the National Electrical Code, ANSI/NFPA No. 70—1984, provides information with respect to proper grounding of the mast and supporting structure, grounding of the lead-in wire to an antenna discharge unit, size of grounding con-

ductors, location of antenna-discharge unit, connection to grounding electrodes, and requirements for the grounding electrode. See Figure.

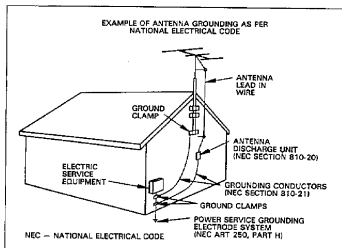

- 18. Power lines** — An outdoor antenna should be located away from power lines.

**Notes:**

1. Item 3 is not required except for grounded or polarized equipment.
2. Item 17 and 18 are not required except for units provided with antenna terminals.
3. Item 17 complies with UL in the U.S.A.

# System connections

Make connection as shown below. When connecting the related system components, refer also to the instruction manuals of the related components.

Do not plug in the power lead until all connections are completed.

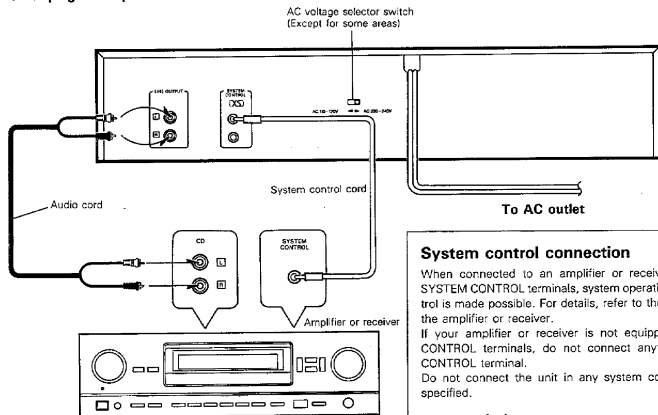

## System control connection

When connected to an amplifier or receiver having KENWOOD SYSTEM CONTROL terminals, system operation such as remote control is made possible. For details, refer to the instruction manual of the amplifier or receiver.

If your amplifier or receiver is not equipped with the SYSTEM CONTROL terminal,

Do not connect the unit in any system configuration other than specified.

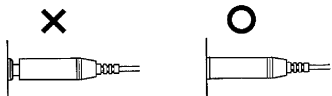

- Be sure to insert the system control cord plugs fully into the SYSTEM CONTROL terminals.
- If the system control cord and audio cords are not connected properly, the automatic system governing remote control and system functions will not operate.

## Notes:

1. Connect all cords firmly. If connections are loose there could be loss of sound or noise produced.
2. When plugging and unplugging connection cords, be sure to first remove the power cord from the AC outlet. Plugging/unplugging connection cords without removal of the power cord can cause malfunctions or damage to the unit.

## ■ Disc handling precautions

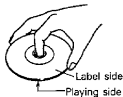

### Handling

Hold compact discs so that you do not touch the playing surface.



Do not attach paper or tape to either the playing side or the label side of compact discs.

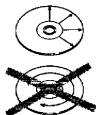

### Cleaning

If fingerprints or foreign matter become attached to the disc, lightly wipe the disc with a soft cotton cloth (or similar) from the center of the disc outwards in a radial manner.



### Storage

When a disc is not to be played for a long period of time, remove it from the CD player and store it in its case.

# Controls and indicators

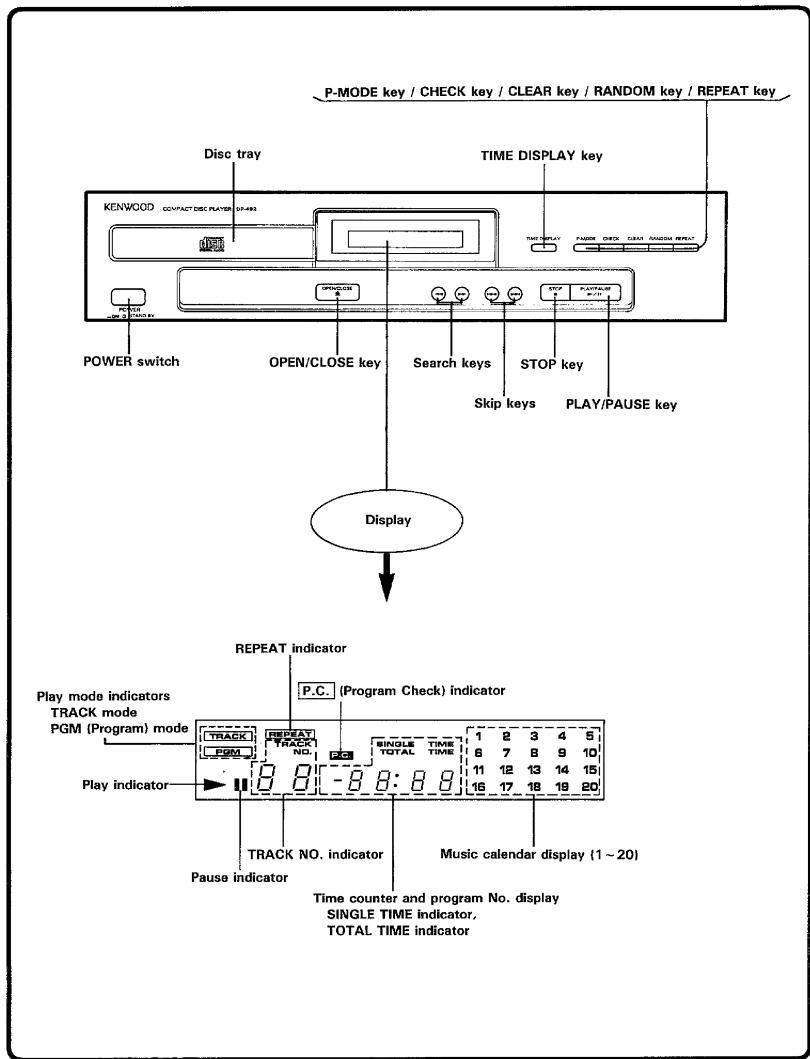

# Manual play (TRACK mode)

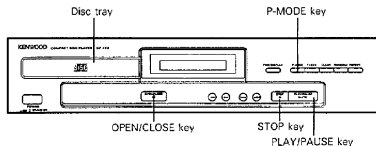

## ■ Playing a CD from the beginning

1 Press the POWER switch to ON.

2 Load a CD.

① Open the disc tray.



② Place a disc on the tray.

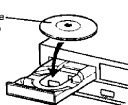

③ Close the tray.



- Hold the disc taking care not to touch the side to be played.
- Be sure to place only one CD at a time.

TRACK indicator lights up.

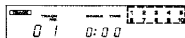
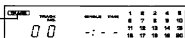

The track Nos. recorded on the CD are displayed.

3 Start playback.

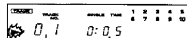
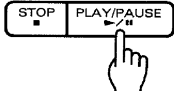

Track No. being played

Elapsed time from the beginning of track being played

- In a few seconds, playback starts from track No. 1.

To pause CD play

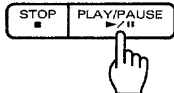

To resume playback, press the  key again.

To stop CD play

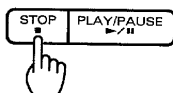



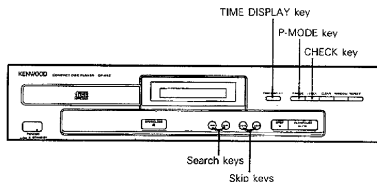

## ■ Listening from the desired track

Select a track No. of the desired tune.



- The selected track No. and play indicator are displayed and the play starts.
- When the key is pressed once during play, the track starts again from the beginning.

To fast forward or backward



- The fast forward or reverse speed increases as the key is held depressed.
- The track will start to play from where you release the key.

When this unit is connected to a KENWOOD amplifier or receiver with a system control cord, and when numeric keys are provided in the remote control unit supplied to the amplifier or receiver, the track No. can directly be selected.

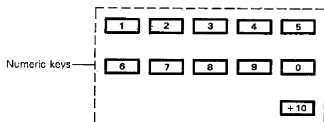

For details, refer to the Instructions supplied with the amplifier or receiver.

Notes:

1. If a track No. which is not present on the CD is selected while the tray is open, the last track on the CD will be played.
2. Such a selection is not accepted after the tray has been closed or playback has started.

## TIME DISPLAY key

Press the **TIME DISPLAY** key when you want to check the elapsed time and remaining time of the track being played. Every time the **TIME DISPLAY** key is pressed, the displayed time is switched as shown below.

The time information display may not appear when playing a CD containing 44 or more tracks or if the total playing time of tracks programmed in the PGM mode is 100 minutes or more. In such a case, the display will show "— : — : —". Only the "SINGLE TIME" is displayed during random play.

TIME DISPLAY



SINGLE/TOTAL TIME display

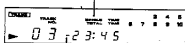

The remaining time is displayed with the "—" (negative) sign.

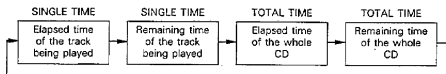

# Programmed play (PGM mode)

Up to 20 tunes can be programmed in the desired order and can be played.

## ■ Playing desired tracks in desired order

### 1 Enter the PGM mode.

Press the **P-MODE** key.

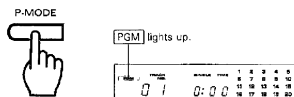

### 2 Program desired tracks in desired order.

① Select a tune to be programmed.

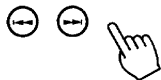

② Press the **P-MODE** key.

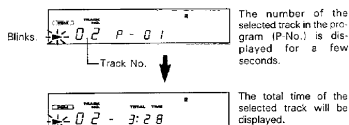

- Repeat steps ① and ②. Up to 20 tunes can be programmed.
- When selecting a tune with the numeric key in the remote control unit, it is not necessary to press the **P-MODE** key after selecting a tune.
- If you made a mistake, press the **CLEAR** key and select the correct track.

### 3 Start playback.

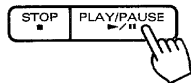

- Tracks are played in the order they are programmed (P.No.).
- If one of the skip keys (**▶▶**) or (**◀◀**) is pressed during programmed playback, the track being played is skipped in the forward or reverse direction.

### To check the programmed order

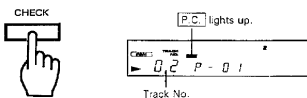

- Every time the **CHECK** key is pressed, the track No. and the order it was programmed (P.No.) are displayed in the order of programming.
- The previous display will resume in a few seconds.

### To resume normal playback



- The playback in the order of the track Nos. on CD will start after the track being played.

### To stop programmed playback

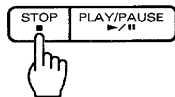

### Auto-Space function

During playback in the program mode, a space of about 4 seconds is reserved automatically between the programmed tracks. This function is provided to facilitate the DPSS function of the cassette deck. However, such a space could also be reserved in case the sound of two tracks are continued, for example with some classic music and live recordings.

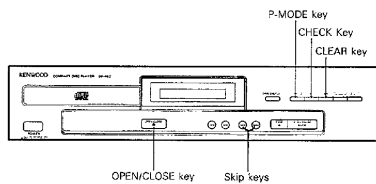

### ■ To add a track to the program

**1** Press the STOP key.

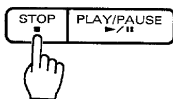

**2** Select the track No. to be added.



**3** Press the P-MODE key.



### ■ To clear tracks from the program

**Clearing from the last track**



- Every time the key is pressed, tracks are cleared from the last track in order.
- The track being played cannot be cleared.

**Clearing the whole of program**

Press either of these keys



# Repeated play

## ■ Repeated playback

### Repeated playback of programmed tracks

#### 1 Enter the PGM mode.

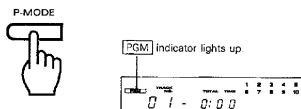

#### 2 Select the desired track(s).

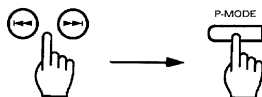

- All of the selected tracks will be played repeatedly.
- If only one track is selected, that track will be played repeatedly.

#### 3 Press the REPEAT key.

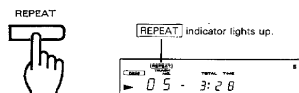

#### 4 Start playback.

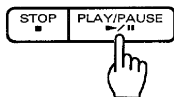

### Repeated playback of the whole CD

#### 1 Enter the TRACK mode.

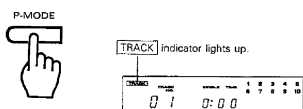

#### 2 Press the REPEAT key.

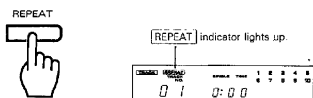

#### 3 Start playback.

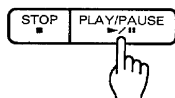

### To resume normal playback

Press the **REPEAT** key again.

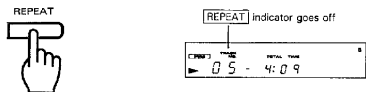

- The playback will be resumed under the CD player mode set before the repeat.

# Random play

The tunes to be played are automatically selected and played (at random).

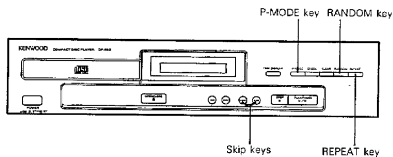

## ■ To perform random play

### 1 Check that the unit is in the TRACK mode.

- When the [PGM] lights up, press the [P-MODE] key.

### 2 Press the RANDOM key.



- Tunes are automatically selected and played at random.

#### When 7th tune is selected

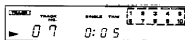

- When the play of the tune is completed, next tune is automatically selected and played.

#### When 3rd tune is selected next

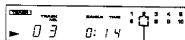

When the play is completed, the track No. indicator goes off.

- Unit enters stop mode when all the tunes in the disc are played.
- When the unit is set to repeat mode, random play is repeatedly carried out.

### To select another tune during play



- When [SKIP] is pressed once, play starts at the beginning of the current tune.

### To cancel random play

Press again.



- Play continues in the order of the track No.

# Maintenance

## ■ Beware of condensation

When water vapor comes into contact with the surface of cold material, water drops are produced.

If condensation occurs, correct operation may not be possible, or the unit may not function correctly.

This is not a malfunction, however, and the unit should be dried. (To do this, turn the POWER switch ON and leave the unit as it is for several hours.)

Be specially careful in the following conditions.

- When the unit is brought from a cold place to a warm place, and there is a large temperature difference.
- When a heater starts operating.
- When the unit is brought from an air-conditioned place to a place of high temperature with high humidity.
- When there is a large difference between the internal temperature of the unit and ambient temperature, or in conditions where condensation occurs easily.

## ■ Note related to transportation and movement

Before transporting or moving this unit, carry out the following operations.

1. Turn the power ON but do not load a disc.
2. Wait a few seconds and verify that the display shown appears.
3. Turn the power OFF.

TRACK	TRACK NO.	SINGLE TIME	1	2	3	4	5
	n 0	d i s c	6	7	8	9	10
			11	12	13	14	15
			16	17	18	19	20

## In case of difficulty

What appears to be a malfunction may not always be serious. If your unit should not perform as expected, consult the table below to see if the problem can be corrected before seeking help from your dealer or service representative.

Symptom	Cause	Remedy
No power is applied with the POWER switch ON.	<ul style="list-style-type: none"><li>Power plug is loosely connected.</li><li>With the power plug connected to the switched AC outlet of an amplifier, the power of the amplifier is turned off.</li></ul>	<ul style="list-style-type: none"><li>Insert the power plug firmly to the AC outlet.</li><li>Turn the amplifier's power ON.</li></ul>
Disc has been placed but it cannot be played.	<ul style="list-style-type: none"><li>The disc is placed upside down.</li><li>The disc is very dirty.</li><li>The disc is scratched or damaged.</li><li>Dew is condensed on the optics lenses.</li></ul>	<ul style="list-style-type: none"><li>Place the disc properly, with the labeled side up.</li><li>Clean the disc then play it again.</li><li>Replace the disc.</li><li>Remove condensed dew by referring to "Be-ware of condensation".</li></ul>
Sound is not produced.	<ul style="list-style-type: none"><li>Disc is not placed.</li><li>The CD player is not set in the play mode.</li><li>The disc is very dirty.</li><li>The disc is scratched or damaged.</li><li>The connection cords are inserted loosely.</li></ul>	<ul style="list-style-type: none"><li>Place a disc and play it.</li><li>Press the play/pause key.</li><li>Clean the disc then play it again.</li><li>Replace the disc.</li><li>Connect all connection cords firmly.</li></ul>
Sound skips.	<ul style="list-style-type: none"><li>The disc is dirty.</li><li>The disc is scratched or damaged.</li><li>Vibrations are applied to the CD player.</li></ul>	<ul style="list-style-type: none"><li>Clean the disc then play it again.</li><li>Replace the disc.</li><li>Install the system in a place which is not subject to vibrations.</li></ul>

Notes:

- This system is microprocessor-controlled, so malfunction may occur due to external noise or interference noise. In such a case, unplug the power cord, plug it and turn power on again.
- Do not use contact cleaners because it could cause a malfunction. Be specially careful against contact cleaners containing oil, for they may deform the plastic components.

